



LOADING BAY EQUIPMENT



GANDHI
Automations Pvt Ltd

India's **No.1** Entrance Automation & Loading Bay Equipment Company

EUROPEAN COLLABORATION AND TECHNOLOGY WITH INNOVATIVE AND CREATIVE ENGINEERING FOR MORE THAN 25 YEARS



A PARTNER WHO STANDS BY YOUR SIDE

Quality & Safety - Our Priority

Dock Levelers and automation for Sectional Overhead Doors are CE certified, manufactured in accordance with

Standard(s) : EN 1398, EN 13241-1 : 2003+A1:2011

Directive(s) : 2006/42/CE, 2004/108/CE

Gandhi Automations design, develop, manufacture and execute its products strictly in accordance with the above mentioned EN standards.

You are assured with our best quality products, safe operation and after sales service 24/7.

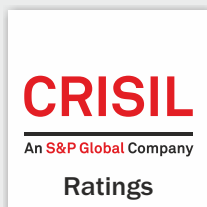

ORIGINAL SPARE PARTS

Guaranteed original spare parts availability for 10 years



CONTENTS

- 4 | Our Quality for Your Safety

- 6 | Loading Bay Equipment - Quality Engineered

- 8 | Dock Levelers
 - Radius Lip Dock Levelers
 - Forklift Roll-off Barrier Lip Dock Levelers
 - Telescopic Lip Dock Levelers
 - TRIO Telescopic Lip Dock Levelers - TTDL
 - Vertical Storing Radius Lip Dock Levelers - VSRDL
 - Vertical Storing Telescopic Lip Dock Levelers - VSTD
 - Ergosafe Lip Dock Levelers
 - Pneumatic Dock Levelers
 - Edge-of-Dock Levelers
 - Top of Dock Levelers

- 24 | Dock Shelters & Seals
 - Retractable Dock Shelters
 - Inflatable Dock Shelters
 - Cushion Dock Shelters
 - Combi Dock Seal
 - Van Cushion Shelters

- 32 | Accessories for Safe Docking

- 36 | Sectional Overhead Doors - Quality Engineered
 - Porto
 - MaxVista
 - Kompakt

- 52 | Dock House

- 53 | Automation Systems

Our Quality For Your Safety

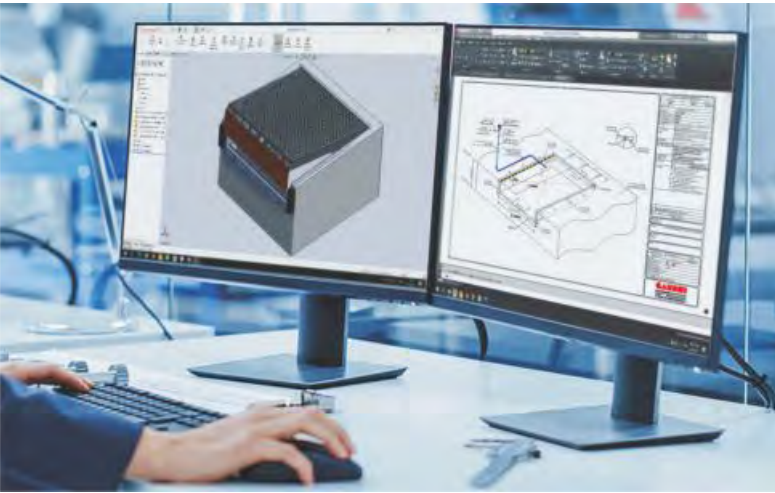

Gandhi Automations Pvt Ltd is India's No.1 Entrance Automation & Loading Bay Equipment Company. Since 1996, we have been designing, manufacturing, exporting and installing products that are hassle-free, safe and easy to operate. Gandhi Automations Pvt Ltd is a globally well-renowned brand, which is a result of years of hard work, innovation, commitment to quality & reliable customer service. We are a Government of India recognised 'Star Export House'.

Our comprehensive product portfolio consists of :

High Speed Industrial Doors, Dock Levelers & Dock Shelters, Rolling Shutters, Sectional Overhead Doors, Aircraft Hangar Doors & Shipyard Doors, Gates & Boom Barriers.

Head Office

Headquartered in Mumbai, the commercial capital of India, our company has expanded its manufacturing capacity, operations, geographical reach and customer base globally. Today our products are marketed by us and our distributors in more than 70 countries across the globe.

Competent Advice

Proper customer guidance and service are our top priorities. Our well trained and experienced specialists are always at your disposal from the project planning stage to final stages of handover, inspection as well as training. They help you choose a perfect product solution tailored to meet your requirements.



Quality Management

The company caters to following certifications : ISO 9001 : 2015, ISO 14001 : 2015, ISO 45001 : 2018 by TÜV Nord. This has resulted in implementing continuous improvement towards personnel training, production, equipment calibration, machinery maintenance, logistics and customer relations.

Nationwide Network

Ahmedabad	■	Goa	■	Kolkata	■	Raipur	■
Bengaluru	■	Guwahati	■	Lucknow	■	Ranchi	■
Bhopal	■	Hyderabad	■	Mangalore	■	Surat	■
Bhubaneswar	■	Indore	■	Nagpur	■	Vadodara	■
Chandigarh	■	Jaipur	■	New Delhi	■	Visakhapatnam	■
Chennai	■	Jamshedpur	■	Patna	■		
Coimbatore	■	Kochi	■	Pune	■		



Advance Manufacturing

Our strategically located state of the art manufacturing and warehousing facility of 4,00,000 sq. ft. near Bhiwandi (40km NE of Mumbai) ensures high-quality product output and short delivery time.

The constant innovation and creative engineering applications of Gandhi Automations is a result of extensive and accurate in-house research and development.

All essential product components & accessories as well as control technology units are designed in-house and produced using European collaboration and technology.

Our product engineering team uses latest software applications combined with advanced machinery to offer our customers an excellently engineered, efficient and finished product.

Installation, Commissioning & Service

Our team of committed and diligent engineers and technicians are at your service round the clock; many of whom are trained at advanced training centers in Europe so as to ensure perfect installation and trouble-free commissioning according to the specifications. Thus, always assuring product reliability and longevity.



Packaging & Dispatch Area

Special care and all necessary precautions are taken while packaging the products for dispatch. Each consignment is supervised by a team of experts who ensure that material is dispatched safely, efficiently and promptly.



Dynamic Customer Service

Our Customer Care team offers 24x7 service. We lay great emphasis on exceptional after-sales service and provide spares, preventive maintenance and AMC (annual maintenance contracts) for minimum downtime ensuring durability and drive maximum ROI.

Our widespread service network assures response time to be minimum.

In rare case of any product failure, all you need to do is reach for the telephone.



TOLL FREE

1800 209 0200

From Anywhere in India

One call and our highly trained service technicians will be on their way in a fully equipped customer service van with wide range of original spares.

Loading Bay Equipment - Quality Engineered





Gandhi Automations offer complete logistic solutions by providing Dock Levelers, Dock Shelters, Sectional Overhead Doors and Dock Houses. As all components for your Loading Bay are available from a single source, the whole process - from product development and design to manufacture, installation and service are optimally co-ordinated, which ensures smooth loading and unloading at your Loading Bay.

The Dock Levelers from Gandhi Automations are manufactured conforming to the European Standard EN 1398 and using advanced robotic welding technology to create a precision based engineered product.

Dock Levelers allow safe and quick unloading of goods from the vehicles thus minimizing energy used, greater savings on heating & chilling costs & help maintaining the quality of transported goods.

Dock Shelters provide an optimum seal between the internal and external environments and assist in reducing the energy consumption. Dock Shelters in combination with a Dock Levelers eliminate the need for a ramp and canopies & ease of operation.

Sectional Overhead Doors are ideal for closing a loading bay; insulated Rolling Shutters can also be utilized alternately.

Gandhi Automations fabricate Dock Houses that are completely self-contained loading bays & can be installed directly on the building thus maximizing available usable space within the building.



Dock Levelers

Built in conformity with
EN 1398



Dock Levelers offered by Gandhi Automations are designed as per EN 1398 standard for the most demanding loading and unloading operations. Dock Levelers facilitate smooth and safe transition by compensating the difference in heights between the loading bay and the vehicle. A Dock Leveler is not simply a bridge for connecting a vehicle but a guarantee and efficient working environment to comply with the safety in work regulation.

The platform is constructed for a carrying capacity of 6t or 9t point load in almond anti-slip steel, with degreasing, phosphating, oven dried epoxy antirust + epoxy final coat finish and robotically welded supporting beams to create a precision engineered product. It has a self-supporting base construction.

The sturdy articulated steel construction is safely and reliably controlled via an electro-hydraulic system. A single push button activates the Dock Leveler into operation.

The most advanced concept of our Dock Levelers is to have the whole drive unit contained in a wall box which is installed on a wall inside the warehouse, at eye level, which allows for easy and economical maintenance, without the necessity to manoeuvre under the platform or inside the pit, where traditional powerpacks and controls are usually installed: an undoubtedly dangerous, dirty and uncomfortable operation.

All Dock Leveler controls offer the option of mutual safeguarding of the Dock Door and Dock Leveler to prevent damage.



It goes without saying that our Dock Levelers meet all the relevant standards and directives:

- EN 1398:2009 Dock Levelers
- Machine Directive 2006/42/EC
- Low-Voltage Directive 2014/35/EU
- Electromagnetic Compatibility Directive 2014/30/EU

Radius Lip Dock Levelers



Radius Lip Dock Levelers allow the dock to connect with the truck bed, thus making it possible to drive directly on and off with forklift trucks etc.

It enables a forklift or pallet truck to drive through on and off the vehicle with the material.

The self-cleaning lip hinging the self cleaning lip hinging system does not retain its position during non-use with automatic end-of-run, so as to keep the 25 mm security distance between the folded lip and structure as per EN 1398 & EN 349.

CE European Certification. Robotically welded platform and lip in anti-slip steel.

Standard dimensions in mm, 6t point load (15t evenly distributed, 9t point load (22t evenly distributed) or MAXI 12t point load.

Model	Platform width	Platform length	Lip length	Pit width	Pit height
RDL 2025	2000	2500	410	2040	550
RDL 2030	2000	3000	410	2040	550
RDL 2035	2000	3500	410	2040	550
RDL 2040	2000	4000	410	2040	550
RDL 2045	2000	4500	410	2040	550
RDL 2225	2200	2500	410	2240	550
RDL 2230	2200	3000	410	2240	550
RDL 2235	2200	3500	410	2240	550
RDL 2240	2200	4000	410	2240	550
RDL 2245	2200	4500	410	2240	550

*Other dimensions available on request.

Forklift Roll-off Barrier Lip Dock Levelers



Dock Leveler with Forklift Roll-off Barrier Lip protects closed overhead doors from impact damage and prevents accidental forklift roll-off when the overhead door is open and no trailer is stationed at the dock.

When the dock is in use, the lip remains flush with the deck, providing a smooth transition for material loading and unloading.

Two cylinder hydraulic technology for better stability, one for the lifting of the platform and one for the lifting of the hinged lip.

CE European certification. Robotically welded platform and lip in anti-slip steel. Self-cleaning lip hinging system.

Standard dimensions in mm, 6t point load (15t evenly distributed), 9T point load (22t evenly distributed).

Model	Platform Width	Platform Length	Lip Length	Pit Width	Pit Height
FDL 2025	2000	2500	600	2040	550
FDL 2030	2000	3000	600	2040	550
FDL 2035	2000	3500	600	2040	550
FDL 2040	2000	4000	600	2040	550
FDL 2045	2000	4500	600	2040	550
FDL 2225	2200	2500	600	2240	550
FDL 2230	2200	3000	600	2240	550
FDL 2235	2200	3500	600	2240	550
FDL 2240	2200	4000	600	2240	550
FDL 2245	2200	4500	600	2240	550

*Other dimensions available on request.

Telescopic Lip Dock Levelers



Telescopic Lip Dock Levelers have a moveable telescopic lip, which provide a larger contact area between vehicle bed and Dock Leveler. Telescopic Lip Dock Levelers are ideal for connecting vehicles unable to drive near dock i.e. sea containers, side loading railway wagons etc.

The truck can be loaded right up to the very last centimeter as the telescopic lip can be positioned with pinpoint accuracy.

Telescopic Dock Levelers are capable to extend its lip upto 1 m. Built in conformity with EN 1398. CE European Certification. Robotically welded platform and lip in anti-slip steel.

Standard dimensions in mm, 6t point load (15t evenly distributed) or MAXI 9t point load (22t evenly distributed).

Model	Platform width	Platform length	Lip length	Pit width	Pit height
TDL 2025	2000	2500	500 - 1000	2040	550
TDL 2030	2000	3000	500 - 1000	2040	550
TDL 2035	2000	3500	500 - 1000	2040	550
TDL 2040	2000	4000	500 - 1000	2040	550
TDL 2045	2000	4500	500 - 1000	2040	550
TDL 2225	2200	2500	500 - 1000	2240	550
TDL 2230	2200	3000	500 - 1000	2240	550
TDL 2235	2200	3500	500 - 1000	2240	550
TDL 2240	2200	4000	500 - 1000	2240	550
TDL 2245	2200	4500	500 - 1000	2240	550

*Other dimensions available on request.

TRIO Telescopic Lip Dock Levelers - TTDL



Trio Telescopic Lip Dock Leveler (TTDL) is a model wherein the lip is divided into 3 parts, each of which is telescopic in nature, with the capability to extend itself all the way up to 500mm in length, providing a larger contact area between the vehicle bed and dock leveler.

This design is the ideal solution for loading bays catering to varied sizes of vehicles, from smaller pick-up trucks & vans to large trucks & trailers while maintaining maximum efficiency and safety.

The telescopic lip of this model provides additional benefits when compared to traditional lip leveler. In situations where the container is filled up to its maximum capacity, there may be a risk of product damage if traditional lip leveler is used. The telescopic lip leveler ensures added protection through its precise lip technology and eliminates such damages.

These are built in conformity with Standard EN 1398.

Standard dimensions in mm, 6t point load (15t evenly distributed)

Model	Platform Width	Platform Length	Lip Length	Pit Width	Pit Height
TTDL 2030	2000	3000	500	2040	960
TTDL 2035	2000	3500	500	2040	1160
TTDL 2040	2000	4000	500	2040	1160

*Other dimensions available on request.

Vertical Storing Radius Lip Dock Levelers - VSRDL

Environmental Control, Food-Grade and Cold Storage Series



The VSRDL Model - Vertical Storing Radius Lip Dock Leveler offers superior energy efficiency, security control and a smooth & effective transition between the warehouse floor and the trailer bed.

VSRDL is perfect for industries such as cold logistics as well as food, beverages, pharmaceuticals and other such applications requiring careful monitoring of temperature and environmental changes.

This model is designed to be generally positioned behind a sectional overhead door, which results in maximum energy efficiency. It also does not require a pit structure due to which thorough cleaning routines can be followed. It comes along with easy to operate controls as well as safety features making the product completely hassle-free.

Standard dimensions in mm, 15t gross load.

Model	Platform Width	Platform Length	Lip Length	Pit Width	Pit Height
VSRDL 1815	1800	1500	410	1970	380
VSRDL 1821	1800	2100	410	1970	380
VSRDL 1915	1950	1500	410	2120	380
VSRDL 1921	1950	2100	410	2120	380
VSRDL 2115	2100	1500	410	2270	380
VSRDL 2121	2100	2100	410	2270	380

*Other dimensions available on request. Optional Lip length 460 & 500mm.

Vertical Storing Telescopic Lip Dock Levelers - VSTDL

Environmental Control, Food-Grade and Cold Storage Series



The VSTDL - Vertical Storing Telescopic Lip Dock Leveler model has a movable telescopic lip of up to 500mm in length, which provides a larger contact area between the vehicle bed and dock leveler.

This dock leveler is known for its energy savings, conformity to cleanliness routines, sanitization and safety as well as cost efficiency. These are utilized in applications such as food industry, pharmaceutical industry, climate-controlled facilities and offer great value in any application where these characteristics are desired at a superior level.

This model allows the sectional overhead doors to completely close down on to the pit (loading dock) floor, which provides the most optimum sealing.

The telescopic lip of this model provides additional benefits when compared to traditional lip leveler. In situations where the container is filled up to its maximum capacity, there may be a risk of product damage if traditional lip leveler is used. The telescopic lip leveler ensures added protection through its precise lip technology and eliminates such damages.

Other features such as sensors on the dock platform and lip, obviates the need of any mechanical limit switches, furthering the product life.

Standard dimensions in mm, 15t gross load.

Model	Platform Width	Platform Length	Lip Length	Pit Width	Pit Height
VSTDL 2115	2100	1500	500	2270	310
VSTDL 2121	2100	2100	500	2270	310

*Other dimensions available on request.

Ergosafe Lip Dock Levelers

CE certified



Ergosafe Lip Dock Leveler offers superior ergonomics with the hinged lip which always maintains a horizontal position. No other dock leveler provides such a smooth and simple transition from loading bay to vehicle.

The unique and innovative parallelogram lip mechanism makes it possible that even a ball can be balanced on the lip, without it moving while it is being raised or lowered.

Ergosafe Lip Dock Leveler is designed to provide substantial lifetime cost of ownership savings by reducing equipment maintenance, damage to goods and injury to personnel resulting in increased safety and productivity.

Standard dimensions in mm, 6t point load (15t evenly distributed).

Model	Platform width	Platform length	Lip length	Pit width	Pit height
EDL 2020	2000	2000	400	2040	700
EDL 2025	2000	2500	400	2040	700
EDL 2030	2000	3000	400	2040	700
EDL 2035	2000	3500	400	2040	700
EDL 2220	2200	2000	400	2240	700
EDL 2225	2200	2500	400	2240	700
EDL 2230	2200	3000	400	2240	700
EDL 2235	2200	3500	400	2240	700

*Other dimensions available on request.

Pneumatic Dock Levelers

CE certified



The RDL-N Model - Pneumatic Dock Leveler offers next generation pneumatic (Air) technology to advance loading bay performance and reliability.

The high-volume, low-pressure air lifting system is an environmentally friendly alternative to oil-powered hydraulics.

The air bags can operate in extreme temperature conditions and withstand pressure without over-inflating.

PVC-coated polyester fibre makes the bags resistant to chemical or puncture damage.

Standard dimensions in mm, 6t point load

Model	Platform width	Platform length	Lip length	Pit width	Pit height
RDL-N 2025	2000	2500	410	2040	550
RDL-N 2030	2000	3000	410	2040	550
RDL-N 2225	2200	2500	410	2240	550
RDL-N 2230	2200	3000	410	2240	550

*Other dimensions available on request.

Edge-of-Dock Levelers for special requirement



Edge-of-Dock Levelers are low cost yet high performing solutions for applications that have standard or little variance in truck bed heights at loading dock. It is ideally suited where pit leveller installation is not feasible. Edge-of-Dock Leveler platform is mounted to the edge of a building wall to assist loading & unloading in a limited working range of 100mm above dock & 100mm below dock.

The open hinge lip construction, carries a lifetime guarantee and has a solid welded connection between the lip plate & the beams under the deck to ensure the lip angle of 7.5° is maintained. This is extremely important when loading / unloading vehicles with bed heights above dock leveller, to ensure that the lip always lays flat on the vehicle floor to avoid the tripping hazard.

Edge-of-Dock Leveler is developed in compliance with the latest European safety standard, EN 1398. It has a capacity of 6T / 9T / 12T and is suitable for use with all types of loading equipment from manual pallet trucks to fork trucks. Robotically welded platform and lip in anti-slip steel.

Gandhi Edge-of-Dock Levelers are available in both versions mechanical (manual) and hydraulic.

Although Gandhi Edge-of-Dock Leveler is operated manually by handling rod, it is supported by a gas spring which makes it easier to operate-lift and swing the platform. The design meets the demands of most simple loading operations and ensures compliance with all ergonomic requirements.

Model	Total width	Platform width	Total length	Lip length beyond bumpers	Bumper projection	Working range above dock	Working range below dock
HYEOD-1830 HP	2255	1830	700	165	520	100	100
HYEOD-2000 HP	2425	2000	700	165	520	100	100
HYEOD-2110 HP	2535	2110	700	165	520	100	100

N.B.: The 'HP' (high profile) model is suitable for forklifts or high clearance ride-on trucks.

Top of Dock Levelers

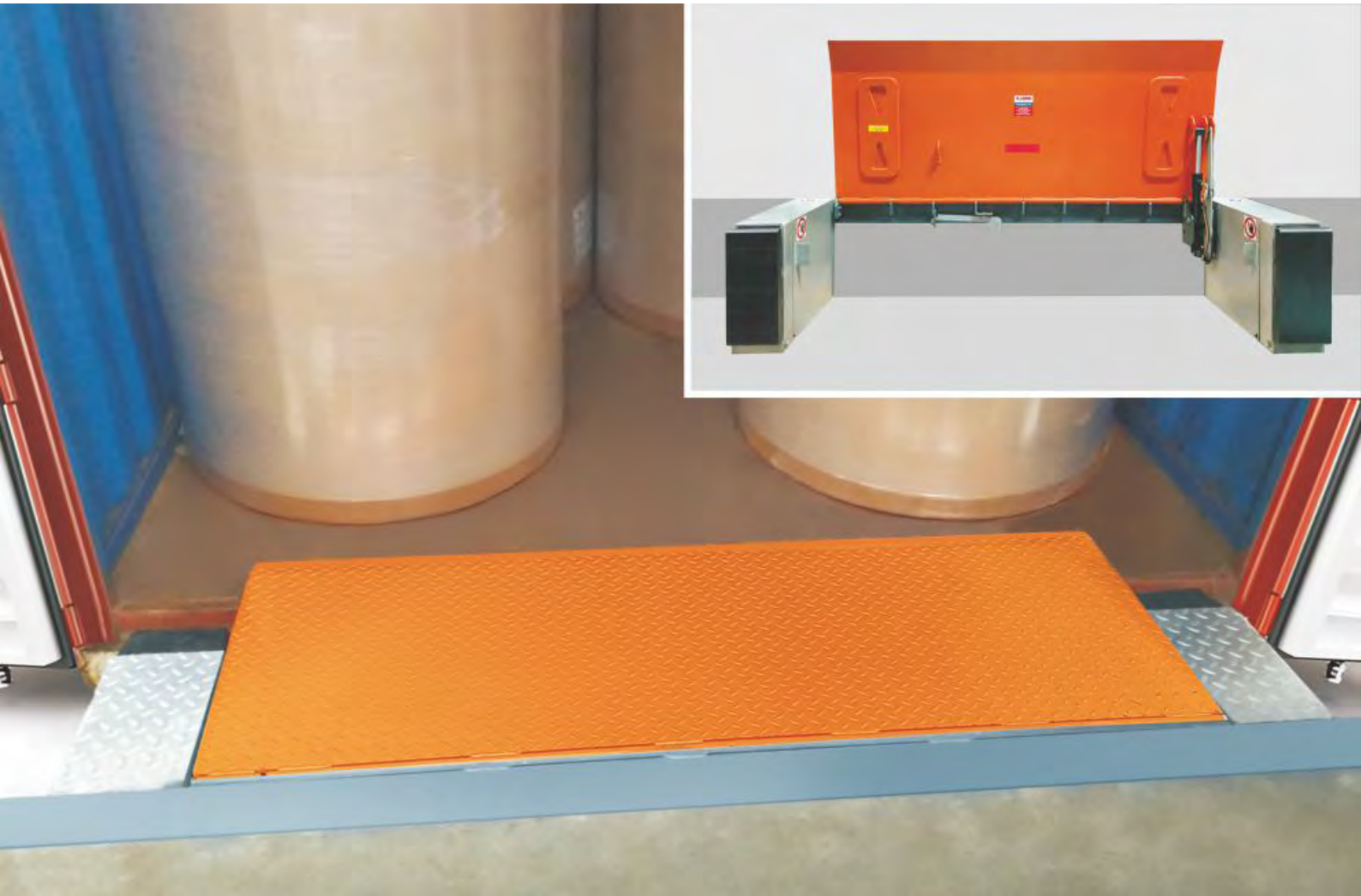

Top of Dock Levelers are ideal where the height differences are minimal between truck bed and loading dock. These levelers have the same high level safety as other dock levelers are easy and fast to operate by one control push button.

Platform is mounted to the edge of a building wall to assist loading & unloading with working range of 70mm above dock & 200mm below dock. Robotically welded platform and lip in anti-slip steel. Platform locks in up-right park position.

These Dock Levelers are developed in compliance with the latest European safety standard, EN 1398. It has a capacity of 6T point load

The open hinge construction, carries a lifetime guarantee and has a solid welded connection under the deck to ensure the platform angle of 7° will be maintained.

Complete cycle with two way selector switch control. When the vehicle reverses against the bumpers the platform can be placed on the vehicle deck by selector switch operation and eliminates manual lifting using the operating handle. After loading or unloading, the vehicle may depart and lip will returns to the parked position by selector switch ,behind the bumpers. This ensures that the next vehicle to dock will do so without damaging the vehicle or the leveler.

Model	Total width	Platform width	Total length	Lip length beyond bumpers	Bumper projection	Working range above dock	Working range below dock
TODL-1830	2290	1830	890	260	670	100	200
TODL-2000	2460	2000	890	260	670	100	200
TODL-2110	2570	2110	890	260	670	100	200

All Hydraulic Dock Levelers in compliance to EN 1398

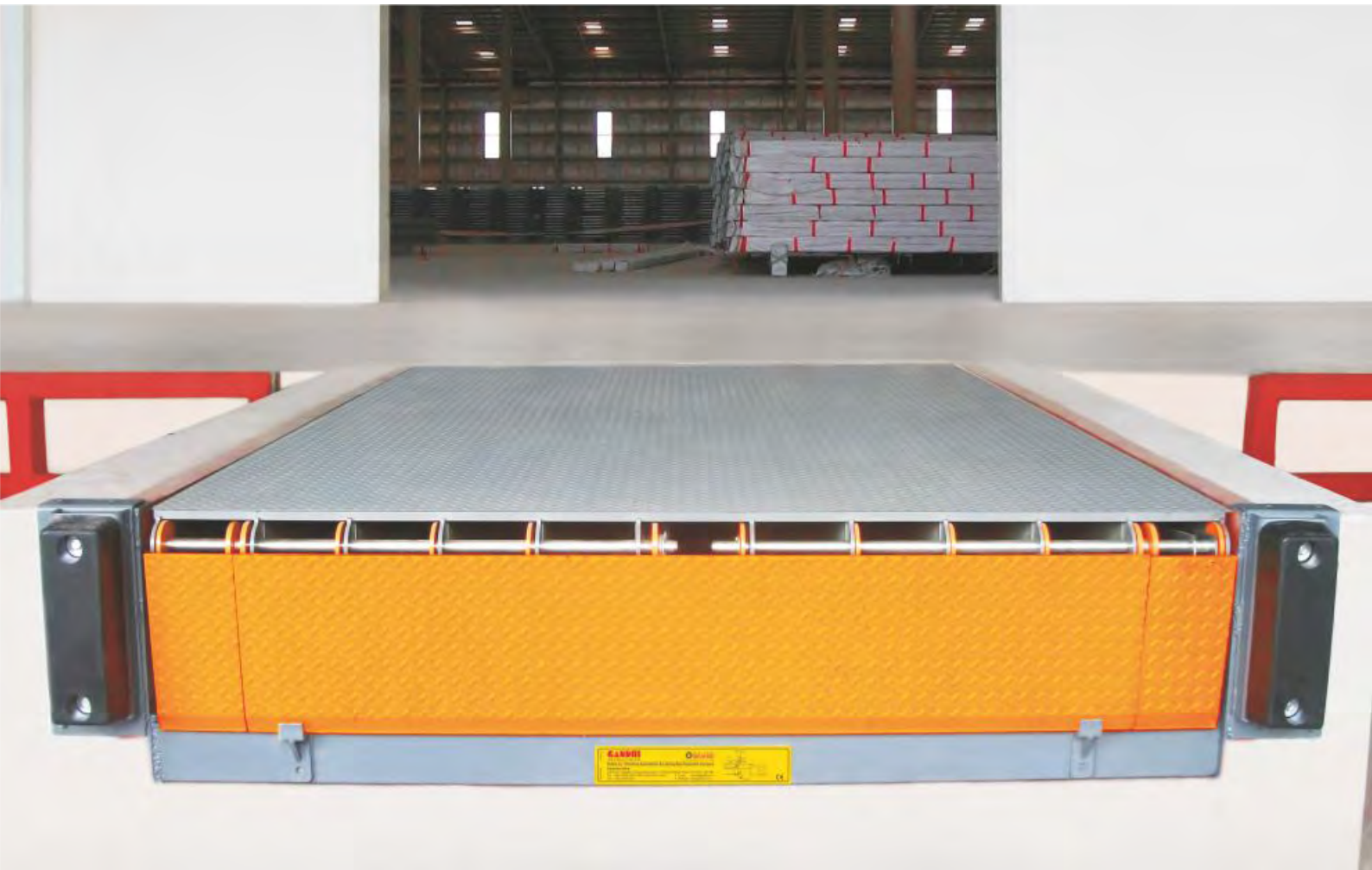

All tools pertaining to the Machine Directive 2006/42/CE are supplied with conformity certification and mark



Compulsory Norms for the Dock Levelers

- When choosing the dimensions of the Dock Leveler, the prescriptions of the EN 1398 are to be considered. It demands a width as wide as the truckbed, and a minimum of 700 mm wider than the forklift truck. The most common choices are widths of 2200 mm side flaps reducing the width for smaller trucks.
- The length has to form a maximum slope affordable for the forklift trucks (max. 8%) or electric pallet trucks (max. 3-4%), thus a standard length of 2500, 3000 mm is usual. The maximum slope of 12.5% stated by the EN 1398 is only the "slippery" limit.
- Standard carrying capacity of the dock leveler: uniformly distributed load of 15t / 22t (or point load of 6t / 9t as defined by EN 1398 totally concentrated on one axle of forklift truck, divided on two wheel prints of 150 x 150 mm at 1m distance).
- Anti-tripping yellow-black stripes 50 mm high under the rim of the leveler and of the pit, for the whole length
- Crossing of the leveler in rest position with full capacity
- Disjointable electric feeding as per EN 60204-1

Important Characteristics of the Dock Levelers

- CE European Certification. Built in conformity with EN 1398.
- Robotically welded platform and lip in anti-slip steel.
- Surface: Degreasing, Phosphating, oven dried epoxy anti-rust + epoxy final coat.
Standard colour Dock Leveler : Grey RAL 7015
Radius Lip : Orange RAL 2000
Telescopic Lip : Grey RAL 7015
- Stainless Steel Dock Leveler available for clean room application
- Hot deep galvanising and non standard colours available on request.
- Electro hydraulic Dock Leveler allows connection to both positive and negative level differences. Maximum positive excursion: 640 mm; Maximum negative excursion: 350 mm
- Safety stop valve is integrated in the lift cylinder: it blocks the Dock Leveler in case of accidental departure of the vehicle.
- Automatic side flaps for the reduction of the width of the lip, for narrow truck beds, automatically closing when the lip is extended and touches the sides of the van.
- Connection between dock and leveler without cutting points of the forklift wheels.
- Lift cylinder- Single effect; Lip cylinder-Double effect, self-venting.
- For swivelling lip levelers the self-cleaning lip that reduces the normally present dock debris, pallet pieces, nails, screws and bolts etc.
- Maximum pressure valve.
- Galvanised Steel sheet foot side protections prevent the feet from getting trapped between the loading platform and the Dock Leveler.
- Yellow / Black side strips to evidence possible steps when the Dock Leveler is in use or underneath the dock.
- Maintenance crutch with positive engagement serves to secure and support the platform during maintenance checks and repairs.
- Lip support in resting position to prevents any cutting or overwhelm.
- Various sizes of rubber bumpers available to stop the vehicle and prevent damage to the Leveler.
- Tilt allows the Dock Leveler to compensate for canted condition.
- Operator & control Unit : Electrohydraulic operator 415 V 50 Hz IP 54. Membrane Push Button with press & hold actuation and emergency stop integrated in IP65 enclosure.



Dock Levelers





Dock Leveler is pre-mounted on a frame, to be laid on a slab built on the bottom of the traditional pit. The leveler is welded at the head and foot of the pit onto the profiles and is powered by electro hydraulic powerpack inside the pit.

Side Flaps

Automatic side flaps allow the choice of a wider platform Dock Leveler is in conformity with the EN 1398 whilst maintaining the ability to level narrow vehicles.

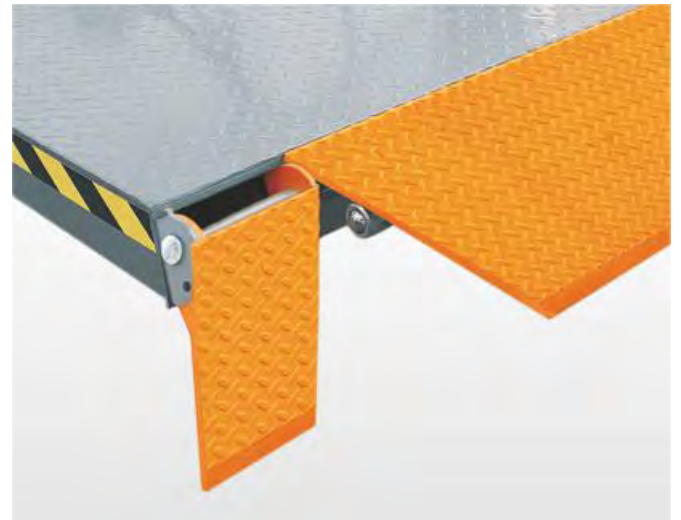

Ready for pouring

Prefabricated Pit

The prefabricated pit or dock tray allows a perfectly squared, flush with pavement pit which is aesthetically pleasing and represents the complete solution to all problems of building a pit. It is assembled in less than a quarter an hour without any possibility of mistakes. The strong steel sheets duly bracketed are structurally calculated to substitute the three side reinforced walls. The monolithic front connection with bumpers made of hanger steel supports is a guarantee of resistance against the shocks of the docking vehicles. It is not necessary to build the perimetrical reinforced walls, which reduce adherence. No reinforcement is necessary. The risk of out-of-squaring pits is eliminated, thanks to the squaring jig. A pit with clearance to receive tail-lift is also available.

Dock Shelters & Seals



Cutting off the inside environment from the outside, it is not only useful to the human working conditions but also for avoiding useless wastes, therefore resulting into energy saving, ecological safeguard, protection of perishable goods and greater working efficiency.

Gandhi Automations offers a complete range of Dock Shelters available for every kind of use and environment; to protect the internal heated environments from the outside cold conditions or the chilled ones from outside heat and also from rain, wind, snow & dust.

Strong and of good quality, the different models are designed to resist to the docking of the vehicles, reducing their impact in different ways.

Better Dock Safety

Dock Shelters seal the gap between the building and the vehicle in such a way that when the Sectional Overhead Door is opened goods and personnel are protected against the harsh weather conditions outside.

Dock Shelters provide a seal between the internal and external environments thus assisting in reduction of energy consumption. The savings in energy costs is considerable.



Dock Level



Ground Level

Retractable Dock Shelters

With a Dock Shelter installed, the truck and dock form one closed entity, shutting out all risks from outside. Both for new and existing buildings we can always realize an optimum sealing, when necessary with a customized Dock Shelter.

The Retractable Dock Shelter is suitable for all vehicle sizes and has flexible design. Retractable steel framework is supplied with hinged arms to provide a shelter which if struck by misaligned vehicle easily retracts behind the bumperface without any damage to the shelters.

The Retractable Dock Shelter is the standard solution for energy-saving oriented operators. The vehicle reverses into the Dock Shelter which seals it off with flexible side and top curtains, giving weather protection during the loading and unloading process. The result is an improved working environment and goods protection. The curtain material has a very high wear and tear resistance.

The trailer backs into the Dock Shelter, with the driver able to centralize upon the clearly visible chevrons on the side curtains. Driving approx. 500 mm into the shelter, the curtain forms an excellent seal around the trailer body. The curtains are pressed out of the door opening creating a perfect entrance for fork lifts into the trailer. The standard width of the shelters is 3500 mm. Over the years this has proven to be the best dimension, giving the best result over a very long period.

Frame is made from articulated Galvanised Steel / Aluminium retractable structure with anti-pinch retraction arms. Specially developed corner pieces of rugged construction give an excellent rigidity to an assembled framework. The rear and front frame is connected by arms with spring integrated at both ends.

Retracting and self-returning system operating on swinging arms, connecting the front to the rear part. They allow the Dock Shelter to retract in case of wrong manoeuvre of the lorry, enabling the automatic return to position thus damage is minimized.

Side and top leaf of standard yellow PVC, bright at the inside with the day light, inset into the throats of the perimeter frame.

Top horizontal leaf 1000 mm height and side horizontal leaves 630 mm width, thickness 3 mm double waving hard armored, for the best adherence to the vehicle sides.

Dock Shelters & Seals



Cushion Dock Shelters

Cushion Dock Shelters are best suitable for loading dock where many vehicles of approximately the same height and width load & unload and where environmental control is important. It provides a virtually air tight seal between the vehicle and building. Even the gaps between the trailer door and bodies are sealed.

Only a cushion shelter design offers you this advantage. This innovative cushion shelter has been specially designed for warehouse with the highest demands regarding the inside temperature, like cold stores and freezer stores.

Since the foam cushion slightly reduces the width of the available door opening, non-palletised goods, are recommended to avoid side cushion damage during loading and unloading.

Construction

The three cushions are made of elastic polyurethane foam, covered with PVC coated polyester fabric, supporting the vehicle pressures and perfectly sealing the three sides, including the space between opened rear doors and sides of the vehicle.

The covers are made of high quality vinyl, or of extremely highly wear resistant polyurethane. The vinyl material strengthened with a fabric insertion is suitable for use in moderate climates. (Vinyl loses its flexibility at temperature below -10°C and it can break down at temperature below -25°C). Polyurethane is eminently suitable for situations of extremely frequent use and/or temperatures below -10°C .

The two vertical cushions have continuous overlapped anti-friction limpets allowing for the up and down heavy friction of the vehicle on its suspensions, during the loading.

The foam cushion of the seal has a recovery rate of 98% and remains flexible in temperatures down to -40°C . It is resistant to most solvents, chemicals, moulds and fungi. The seal covers employ ventilation exhausts vents to ensure rapid compression and decompression without problems. Bold guidance markings at the front of the seal side cushions are useful point of orientation when reversing onto the dock seal to reinforce this correct alignment we strongly advise the use of wheel guide.



Ground Level



Dock Level

Inflatable Dock Shelters

Inflatable Dock Shelters combines an optimum seal and a virtually airtight contact with the vehicles. Ideal for temperature controlled warehouses to seal against summer heat, winter cold, draught, dust and insects. The result is substantial savings on energy, improved working environment, production and safety. Not only do the inflatable side and top seals provide the best possible closure, they also accommodate a wider range of vehicle sizes varying up to 1200 mm in height and 700 mm in width. This feature means that trucks of varying dimensions can still be sealed effectively.

Flexibility Combined with Optimum Closure

The Inflatable Dock Shelter is made of polyester fabric PVC covered, a material resisting to hot temperatures and bad weather conditions. The frame is exceedingly robust and consist of 40 mm insulated panels. The standard cladding color is 'white or grey'. The pneumatic Dock Shelter is to be inflated only when the vehicle is in loading position. The fan can be switched off at the end of the operation and the cushion will rapidly retract to let the vehicle go. Inflatable Dock Shelters provide the most versatile seal available to service the widest variety of truck and trailer configurations.

Contrary to other types of Dock Shelters, the vehicle does not push towards the shelter. Instead the shelter is inflated around the docked vehicle providing complete seaming.

The three cushions inflate under 415 V 50 Hz three phase 0.55 kW fan air pressure until light compression against roof and sides of the lorry. The cushions retract rapidly to their rest position when the fan is switched off for allowing the

departing lorry to be immediately free from cushion pressure. The inflatable side and top seals provide a virtually airtight contact with the vehicle.



*For Inflatable type of Dock Shelters it is strongly recommended to install / fix ground wheel-guides for perfect docking of trucks. This prevents damage to the side panels of Dock Shelters.

Dock Shelters & Seals

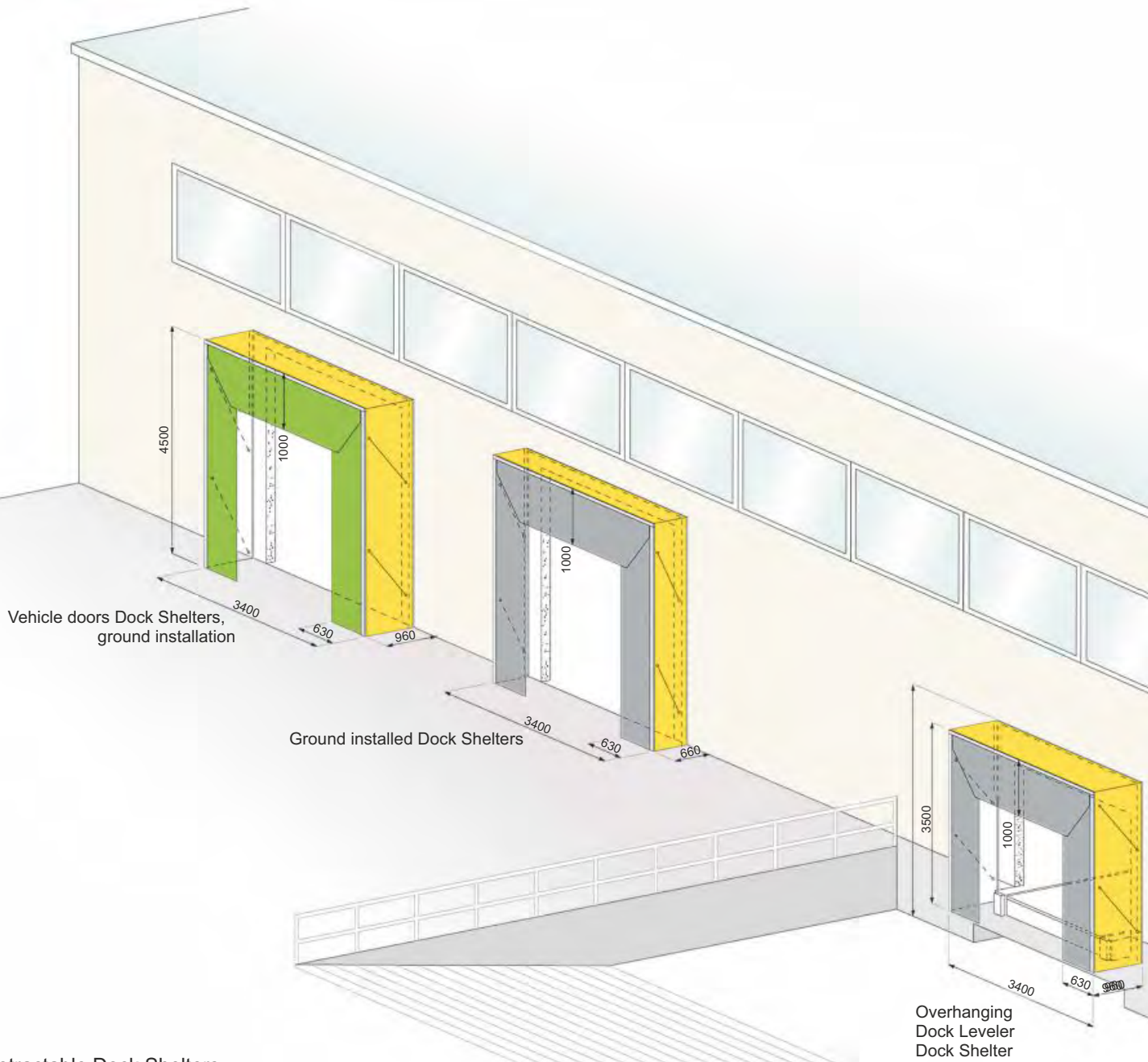

Retractable Dock Shelters



Cushion Dock Shelters





Inflatable Dock Shelters

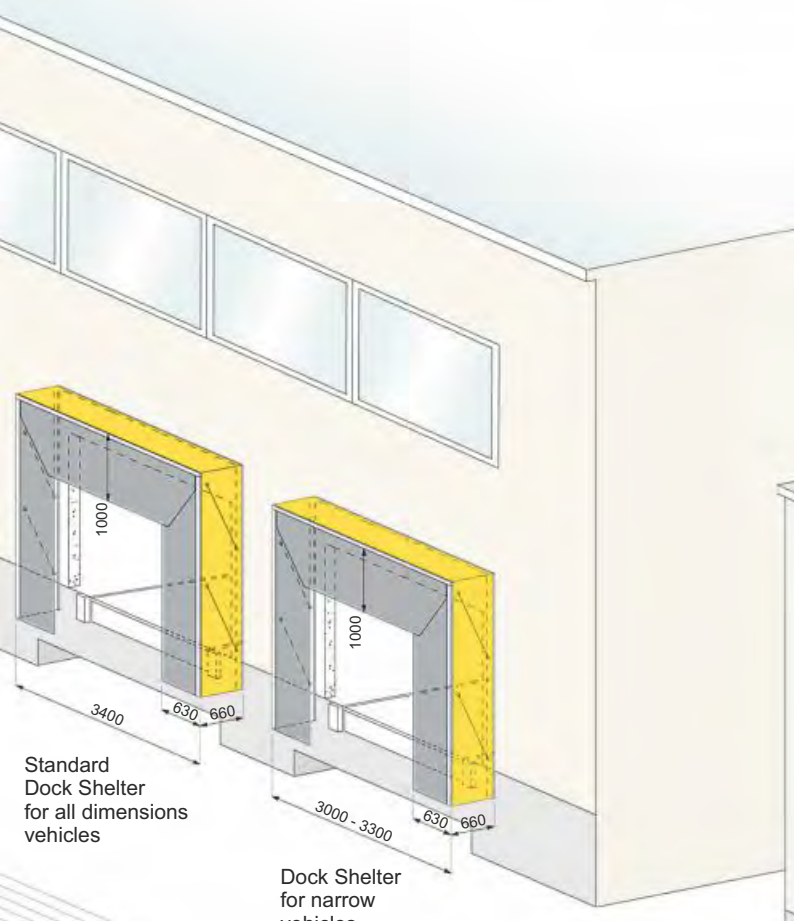
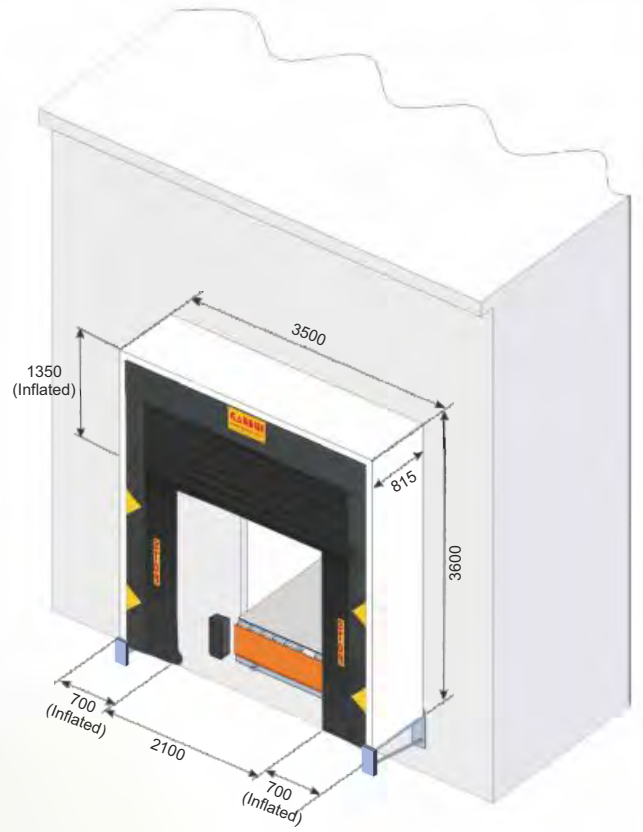

Standard Dock Shelter for all dimensions vehicles

Dock Shelter for narrow vehicles

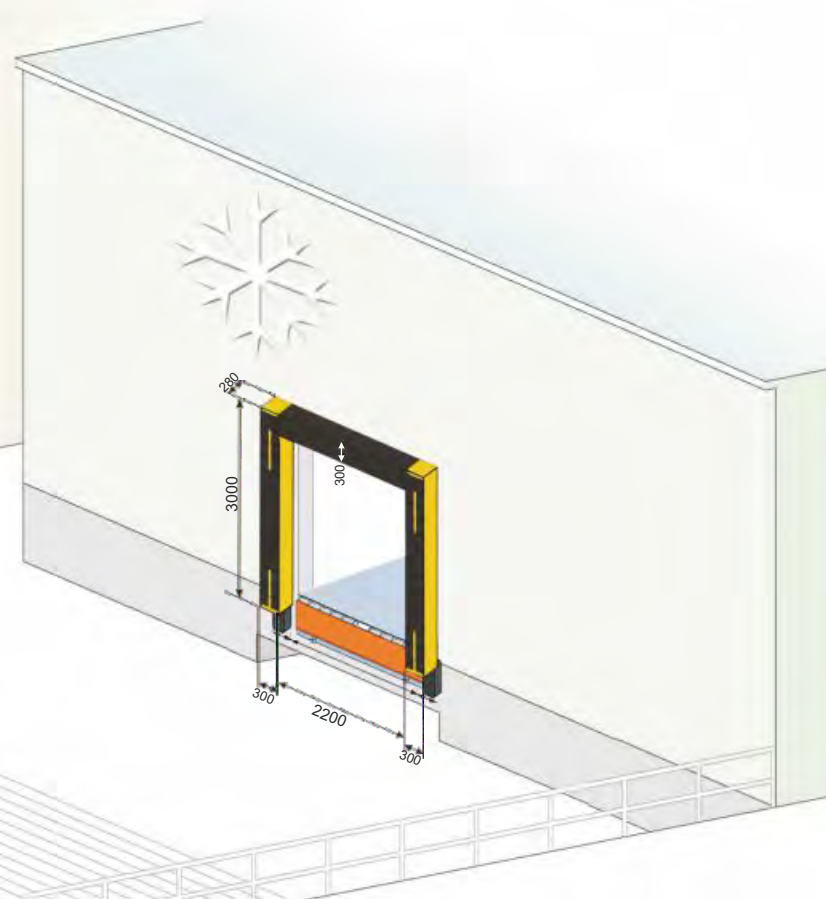

Dock Shelters & Seals

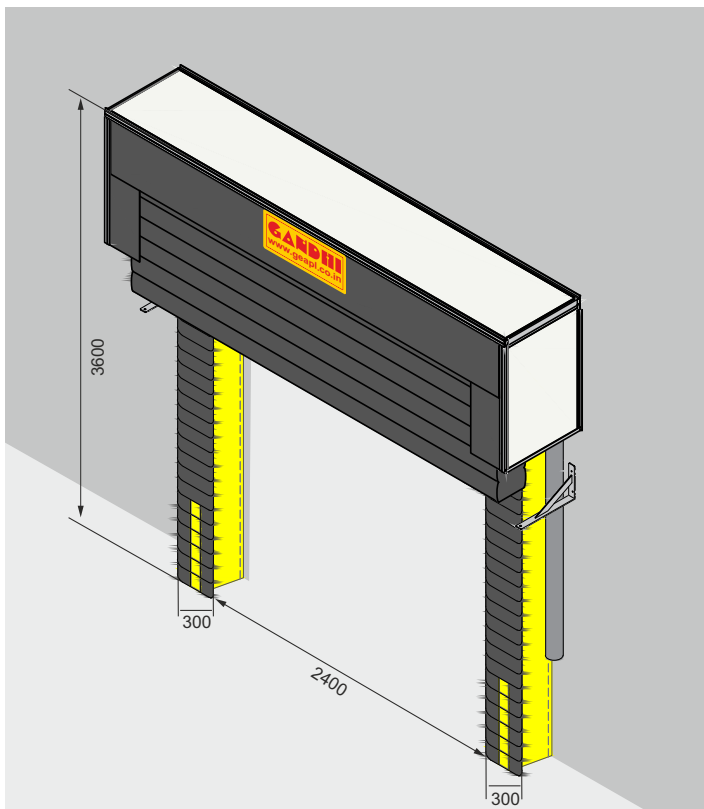

Combi Dock Seals

- Combi Dock Seal is an ideal solution for cold storage facilities with superior sealing & optimum management of temperature and hygiene.
- A perfect combination of Cushion & Inflatable Dock Shelter for loading and unloading narrow vehicles.
- Durable two side cushions made from elastic polyurethane foam, covered with PVC coated, inflatable top cushion made from wear resistant Cordura.
- Supreme protection of the shelter cushions by use of high quality and robust aluminium sandwich profiles and PVC curtains.
- Optimum damage and safety protection due to armoured sections on the front side of cushions with yellow positioning markers.



Van Cushion Shelters

- Specifically developed for docking processes of small sized vans used at parcel distribution centers, e-commerce deliveries, courier services, food deliveries etc.
- The size and shape of the shelter is the ideal solution for vans that have doors which open flush with sides 180 degrees for perfect loading and unloading.
- Strong and soft foam cushions provide complete sealing between the van and the door for energy efficiency within the warehouse without damaging the vans.
- The trapezium design and built-in recess in the top cushion, housing a rear view camera assists the driver in aligning the van accurately onto the loading bay.



Accessories for Safe Docking



Example of early vehicle departure



Motorised Wheel Block System

The most sophisticated electrical hydraulic technology, operated via PLC and is controlled using a button on the control panel in the building. An integral sensor in the wheel block accurately determines the position of the rearmost wheel, where upon the wheel block is automatically extended and the wheel is restrained. The restraint process occurs in approx. 30 seconds regardless of the size and position of the wheel.

- The wheel block applies constant pressure against the wheel to prevent the vehicle from creeping forwards
- No damage to mudguards or side skirts due to the low height of the wheel block. Warning lights are in constant operation while the wheel block is being positioned and an external red/green traffic light ensures clear communication
- Emergency release is possible at all times



Manual Wheel Block System

The wedge is put under a vehicle wheel, as to restrain its movement, which increases the safety-on-work.

- Heavy duty type, with rudder and positioning wheels
- Construction heavy duty rigid plastic component sandwich side covered with stainless steel plates, blocked by passing through tyres

Safety Truck Lock

- The manual and motorised safety truck lock series is a low profile, non-impact design vehicle restraint featuring the hydraulic / mechanical floating system, a large spring-loaded barrier that automatically adjusts to various truck heights, maintaining positive contact during loading operations at all times.
- Barrier stores 225mm high to escape impact from low rear impact guards.
- Barrier automatically adjusts to truck movement during loading.
- Vertical locking hook secures virtually all rear impact guards with in excess of 14.5 tons of restraining force. Self cleaning guide track.
- Vertical operating range from 225mm to 760mm.
- Inside and outside traffic lights for loading and unloading communication.



Wheel Guides for Perfect Docking

Wheel guides are hot dip galvanised steel guides consisting of two round shaped pipes 2 metres long and appropriate diameter. Fixed on the court pavement, in front of the loading bay they grant a perfect docking of the approaching vehicles (10 cm tolerance) and preservation of the equipment. Wheel guides do not affect the wheels of the lorry and does not reach their rims.

Accessories for Safe Docking

Dock Light / Truck Cooler Fan

- Steel articulated arms LED Dock Light 60W in aluminium casing, IP 66.
- It is the perfect solution to bring light in the truck and docking area.
- It is easy to install inside the building next to the loading bay and will lighten every corner of the truck due to its articulated arms.
- Additionally, dock lights can be incorporated with truck cooler fans to keep the environment within the containers cool.



Retractable Dock Safety Barriers

- The Retractable Dock Safety Barrier is designed to stop up to 13,636 Kg.
- Retractable Dock Safety Barrier is made-up of bright black mesh curtain of height 1150mm with three heavy duty restraint strip. It also serves as a highly visible warning for operators and pedestrians.
- It consist of two heavy duty 1200mm high orange warden guards anchored on either side of clear opening, which provides excellent door track protection. During loading or unloading, the dock safety barrier retracts into one of the wardens.
- Helps prevent fork trucks, pallet jacks, and pedestrians from falling off a loading dock.

Anti-Crushing Dissuaders

The anti-crushing safety dissuaders are flexible but resilient to volumes applied on the outer wall of the loading bay, filling the space between the wall of the building and the pillars of the containers of the vehicles. This dramatically reduces the risk of an operator slipping into the space and subject to crushing between the vehicle and the wall in the fatal case of a sudden manoeuvre of the vehicle. The vehicle while docking can compress the dissuader without damaging it, but when it goes away it will return to its original size.



Bumpers

Bumpers are used to indicate the driver that he has arrived in position. The bumpers are separately installed outside onto the side walls of the pit. No loading platform should be without them. They absorb the forces that are generated each time a vehicle docks, thereby ensuring that the Dock Shelter and platform do not get damaged in the process.

- Made of anti-friction full rubber
- Available in various sizes
- Front-top protection plate
- Spring balanced up-down Floating Bumpers move 150 mm up and 90 mm down and rest at dock rim



Super Bumpers fully respond to the necessity of safeguarding the front facade of the building.

- Made of anti-friction full and hard rubber
- 150 mm width, 400 mm height, 80 mm depth with heavy steel support (total depth including steel support, 130 mm)

Mega bumpers larger in dimensions safeguards the front facade of the building.

- Made of anti-friction full and hard rubber
- 250 mm width, 450 mm height, 100 mm depth with heavy steel support (total depth including steel support, 150 mm)



Bumpers with Steel Front Plate

Where greater wear and tear is expected, protective plates on the front of the bumpers are recommended.

- Heavy steel plate for protection front and top loads
- 10 mm thickness for Super bumpers
- 15 mm thickness for Mega bumpers

Sectional Overhead Doors - Quality Engineered





Porto Sectional Overhead Doors are the ideal solution for all industrial and logistic needs. The design and different solutions offered ensure that the door is aesthetically pleasing and perfectly suited in any architectural environment - from modern and traditional industrial buildings to fine commercial buildings. These doors are built to ensure the highest ease and flexibility of use which, in turn, ensures a quick, hassle free and accurate replacement of old doors. Their compact size ensures more available space both inside and outside the premises. Depending on the structure of the building and the requirement a choice can be made from a standard lift, vertical lift, horizontal lift, low headroom or inclined lift.

Porto Sectional Doors come in a wide variety of designs with various features to suit your individual requirement, that guarantee

- Reliable and low-noise operation
- Extreme robustness
- Safe operation in compliance with safety requirements
- Design-oriented surfaces and optimum light solutions



Type of Sectional Doors





Manual Push-Pull Sectional Doors

This type of Sectional Doors are operated by pulling or pushing the doors manually. Counter balancing of the door weight is done using torsion springs within strong suspension shaft to reduce deflection. Due to manual exertion, these doors are ideal for very small size upto width 3000 mm x height 3000 mm.

Chain-Hoist Operated Sectional Doors

This type of Sectional Doors are operated manually by pulling an endless chain. They are relatively easy to operate as compared to Push-Pull type sectional doors as they roll up and down smoothly. Counter balancing of the door weight is done using torsion springs within strong suspension shaft to reduce deflection. The hoist is installed directly in the shaft to enable the manual lifting of the door. These doors are ideal for size upto width 8000 mm x height 6000 mm.

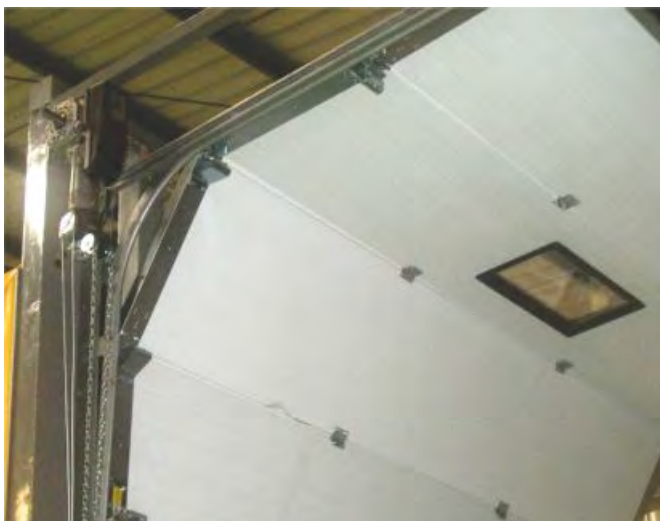

Electrically Operated Sectional Doors

This type of Sectional Doors are operated by using a range of electrical actuators made up of self-braking worm gear with hollow shaft and integrated limit switches with overload protection. During downtime, the option for manual operation is also available.

Types of Installation



Vertical Lift (VL Elevation)



Normal Lift (NL Elevation)



High Lift (HL Elevation)

Sliding System Vertical Section Drawings: Types of Installation

Minimum lintel size - 200 mm

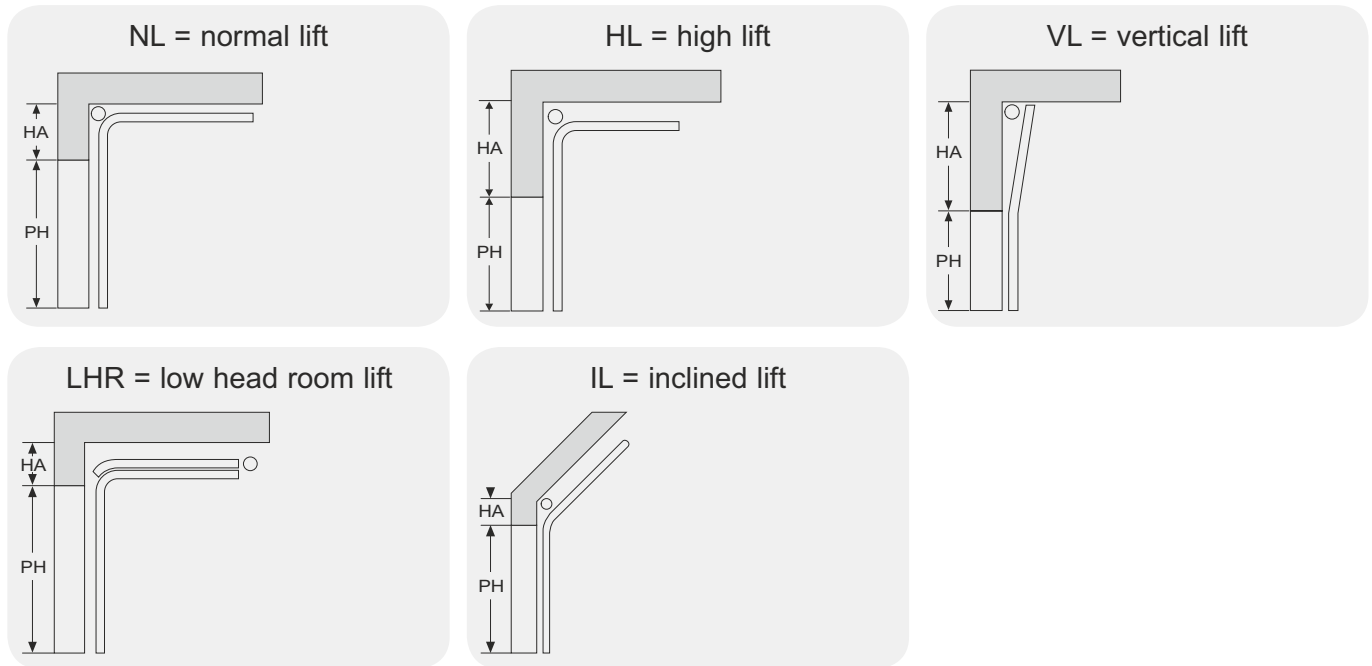

Elevation Details	PL (mm)		PH (mm)		HA (mm)	
	Min.	Max.	Min.	Max.	Min.	Max.
Normal (NL)	1800	8000	1780	5570	420	
				6500	510	
				8000	650	
High (HL)	1800	8000	1780	5500	960	4000
				8000		
Vertical (VL)	1800	6500	1780	5000	PH+300	
		8000		8000	PH+650	
Low Head Room (LHR)	1800	5000	1780	3500	200	
Inclined Lift (IL)	1800	6000	1780	5000	510	
		8000		8000		

Porto

Double-skinned Steel Sectional Doors

Panel

The Panels are sturdy and consist of double-walled steel with a polyurethane hard foam core which is foamed CFC-free. The standard thickness of the sections and therefore of the entire door leaf is 40 mm, which provides superb heat insulation and soundproofing.

The door panels are available in two heights 500 mm and 610 mm.





They are connected with each other by Galvanised Steel hinges. This guarantees safety and durability.

Technical Characteristics

- Density : $\pm 45 \text{ kg/m}^3$
- Adhesive strength : $\pm 0.10 \text{ MPa}$
- Compressive strength : $\pm 0.13 \text{ MPa}$
- Compressive Modulus of Elasticity : $\pm 2.68 \text{ MPa}$
- Thermal conductivity : $\pm 0.14 \text{ W/mK}$
- Heat transfer co-efficient:
 - Panel 610 mm with seal : $U= 0.76 \text{ W/m}^2\text{K}$
 - Panel 500 mm with seal : $U= 0.80 \text{ W/m}^2\text{K}$
 - Panel 610 / 500 mm without seal : $U= 0.53 \text{ W/m}^2\text{K}$
- All panels are lined internally and externally with a protective PVC film

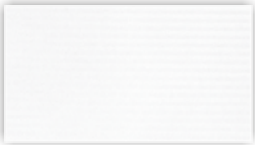

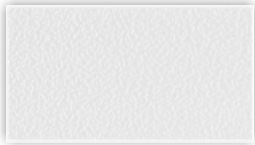
Colours & Finishes Offered

Standard External Microrib	 WHITE similar to RAL 9010	 GREY similar to RAL 9006	 BLUE similar to RAL 5010	Standard Internal Stucco	 WHITE similar to RAL 9010
Optional External Microrib Internal Stucco	Any other RAL colour available on request at surcharge to match the overall appearance of building				



Our Sectional Door design is optimal for customers who need robust, well-insulated and space-saving doors with safety and offer amazing advantages.

Compact Design

Sectional Overhead Door side runners move vertically along the wall and parallel to the ceiling, ensuring optimal use of the available interior space.

Environmental Control

Their heat insulation and soundproofing ensured by insulated panels, improves internal living conditions and energy consumption.

Safe and Secure

First class materials, precise processing and continuous quality checks guarantee perfect safety, reliability and long service life. All our doors comply with safety requirement of European standards EN 13241-1.

Glazing for Light & Aesthetical Look

The panels can also be designed to be combined with thermally insulated panels and aluminium panels featuring transparent acrylic, gridded or meshed windows. This design allows natural light to go through large clear area.

Installation Friendly

Our door installation is fast and simple due to intelligent product optimization without having to compromise on proven quality. Numerous prefabricated parts prevent faults, and reduce the installation time thus increasing efficiency.

MaxVista





MaxVista is a Sectional Overhead Door designed to be combined with thermally insulated panels and extruded aluminium panels, shaped for inserting transparent acrylic, gridded or meshed windows. This combination gives the door a very distinctive look, which enhances the face of both commercial and industrial buildings, where MaxVista blends in perfectly as a practical and decorative feature or solution.

It makes the environment light and pleasant to work in as it allows natural light to go through the large clear area. The aluminium profiles and the glass window sections are highly resistant to the elements and ensure a longer life of the door.



Special Requirements

Over Dimensional Sectional Door for large openings with Safety



We fabricate precisely to your application and building openings that implies to our selection of perfect design, colour, size and maximum stability. Our Sectional Doors fit openings to a maximum width of 15,000 mm and height of 10,000 mm. Future developments and continuous improvement of existing systems are our standard procedure.

Special Requirements

Side Door or Pedestrian Door



For additional easy access for people and small transport vehicles, a separate threshold-free side door or an integrated pedestrian door can provide access even when the Sectional Door is closed. This also saves the heat loss from the building by decreasing the number of times the door is operated making it energy efficient.

If there is enough space, a side door separate from the door installation is a good choice. We offer side doors on request in the same design as the door installation. A pedestrian door integrated in the Sectional Door is always an expedient supplement if there is no space for side door installation. All pedestrian doors open outwards for safety reasons. A special switch on electrically-driven Sectional Doors ensures that door can only be moved when the pedestrian door is closed.



Quality that ensures Safe Door

Silent Door Travel

Robust roller holders made of galvanised steel with adjustable nylon rollers on ball-bearings guarantee a long service life and silent door travel.

Intermediate Hinge

The stable centre hinge is made of galvanised steel connecting the individual door panels precisely.

Finger Trap Protection

The horizontal joints between the door panels are designed in such a way that it avoids the risk of fingers being pinched, if a hand is rested on the moving door panel, both on the inside and outside of the door leaf.

Side Trap Guard

The side frames are completely closed from top and bottom and hence injuries are not possible due to intervention from the sides.

Cables Guided Internally

The carrying cables are guided on the inside between the door leaf and frame. The risk of injuries are excluded as there are no protruding components.

Seals

The seals are made of special anti-aging EPDM that are located in the following hinged points;

- Central seals between the individual panels across the entire width
- Upper doorstop finned seal fitted to seal the door near the lintel
- Vertical seals fitted to the side uprights
- Bottom Seal with rubber profile helps even to compensate for any unevenness in the floor

They ensure total insulation thus avoiding the ingress of air, dust and water.



Safety Features

In Accordance with European Standard 13241-1 



Safe Door Guidance

The rollers are guided precisely in a safety track that ensures derailment guarded operation of the door installation.

Torsion Springs

The door leaf weight counterbalances on Sectional Doors in standard dimensions and is designed with torsion spring assembly. The steel torsion springs have been designed to ensure a standard life from 10,000 to 1,00,000 operation cycles.

Safety Device Against Spring Breakage

This special device immediately stops the door panel from closing in the event of balancing spring breakage.

Safety Device Against Cable Breakage

This special device immediately stops the door panel from moving in case of breakage of the return cables.

Closing Edge Safety Device

A pair of Photocells ensures safe monitoring of the closing edge of the door, stop and reverse if any obstruction is detected before they come into contact with the door.

Stacking Doors - Kompakt



Stacking door is an electrically operated insulated vertically stacking sectional door panels that can be installed in locations where headroom constraints or noise restrictions prevent the use of other conventional industrial doors.

The doors are manufactured as standard from 610mm deep x 40mm thick insulated galvanised panels.

The benefits of the stacking door technology

- No fixation by the ceiling required
- Compact stacking of door panels directly above the doorway enables clear unobstructed positioning of roof lights, light fittings, syphonic piping, crane beams etc into the basic design of the building layout
- The lack of counterbalance springs reduces the need for heavy steel support work at high level thus reducing the cost of the overall door framing
- The unique track guiding system minimises the force on moving parts reducing noise emission during operation and hence reduced cost of operation and maintenance
- Combination of insulated door panels with transparent acrylic window and aluminium profiles provide sophisticated architectural solution and more natural daylight inside your workspace.



Upon opening, the door panels rise vertically and are compactly stored behind the lintel.

The door is attached to the wall without suspension from the ceiling, thus rendering it suitable for almost any installation.



Advantages of Stacking Door

No Overhead Steel Frame

A traditional insulated sectional overhead door requires overhead support from the roof structure unlike the stacking door which simply stacks above the door opening.

Less installation time

The stacking door does not require overhead rails fixed to the roof structure to support the door panels or balancing springs when opened. It is therefore quicker to install and offers reduced maintenance cost.

No Corner Installation Issue

The stacking door does not rely on the roof structure for secondary support for the door panels when opening and hence suitable for corner installations.

More free overhead space

The stacking door stacks above the door opening and provides more free overhead space.



Dock House



Dock House is a self-contained loading bay which is installed in front of the building providing energy efficiency, contributing to hygiene, safety and is space-saving. This means that the actual building does not have to undergo any expensive structural alterations. Dock Houses do not take up valuable internal space of the building and forms a complete loading house that is ideal for ambient and temperature controlled buildings. The design and layout can be adapted to suit the requirements of the site.

Dock Houses are used in the following situations :

- When the manoeuvring space for trucks is insufficient to allow them to dock at a 90° angle
- When extending or converting existing buildings
- When Dock Levelers have to be positioned outside the building in order to avoid thermal bridges

Dock House is made up of following components:

- Dock Leveler
- Dock Shelter
- Sectional Overhead Door
- Roof and Side comprise a sturdy steel frame construction which is clad with double-skinned steel puf panels

Automation Systems

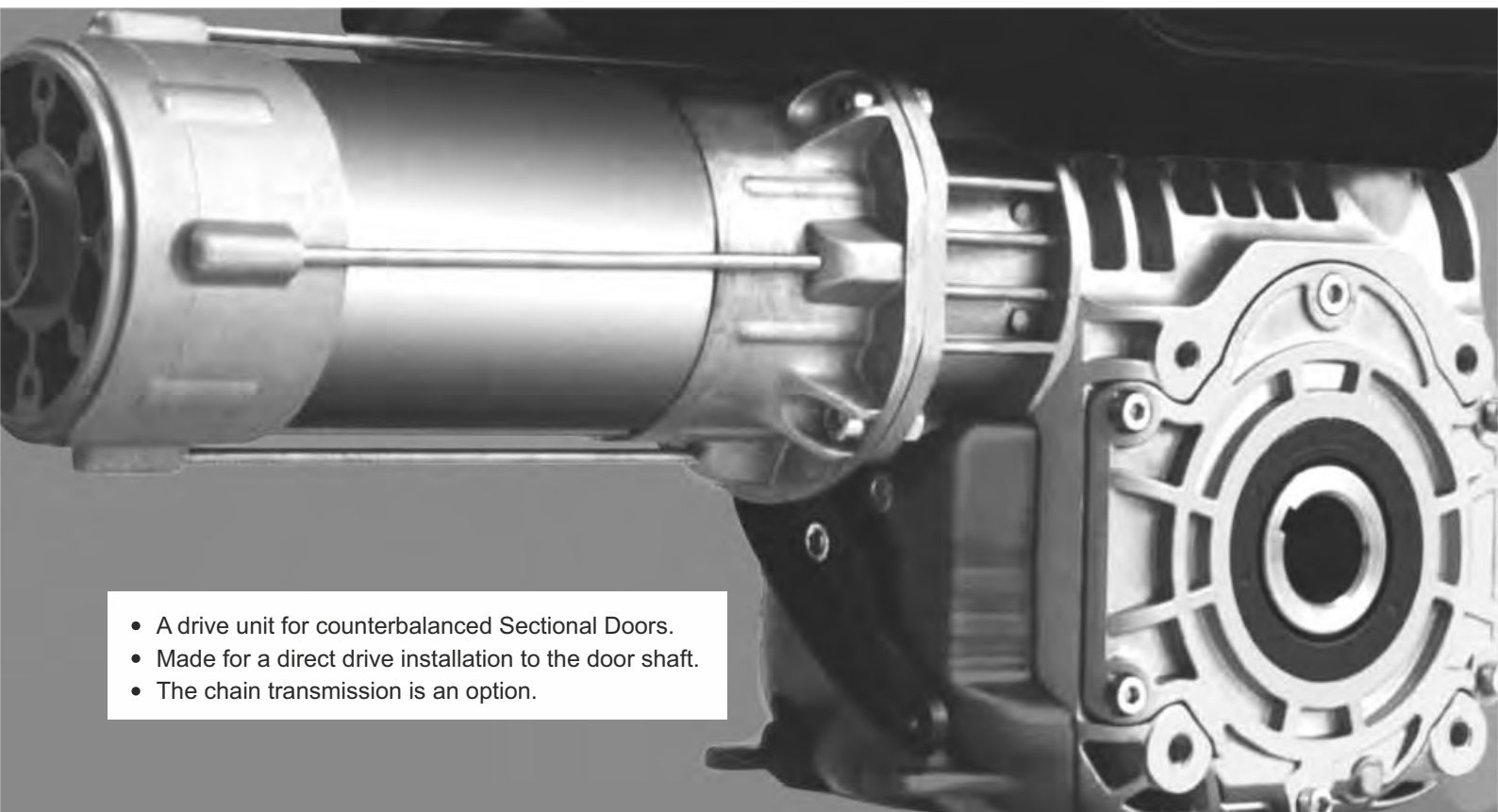

- A drive unit for counterbalanced Sectional Doors.
- Made for a direct drive installation to the door shaft.
- The chain transmission is an option.

Drive Unit is made up of

- A worm gear with hollow shaft
- An electric motor
- Integrated limit switches
- An emergency manual operation

The self-braking worm gear makes the drive irreversible. No need for an electric brake.

Additional Details

European Directives

Drive Unit is made in accordance with product standards EN 13241-1 Doors and EN 12453 Safety for power operated doors.

Duty Rating

The relation between the weight of the door and the number of movements per hour allows to increase the number of movements by reducing the door's weight.

Overload Safety Factor

Motor overload safety factor = 4 x the nominal motor amperage because the starting current of the drive can reach these levels for short periods.

Output Speed

The maximum admissible speed depends on the construction and type of door. The admissible closing speed shall be tuned so that the operating forces must comply with EN 12453.

Manual Operation

In installations of drive with hand crank or hand chain override, the door and self braking gear construction remain inter-connected. No danger of the door crashing down if a spring breaks.

The counter-balancing system should be inspected at least once a year.

Holding Torque

The drive unit is capable of holding the weight of the door when the spring breaks preventing the door leaves from crashing down.

The holding capability is the admissible load bearing of the worm gear construction.

Drive Units

Motors with integrated safety brake for industrial and commercial Sectional Overhead Doors

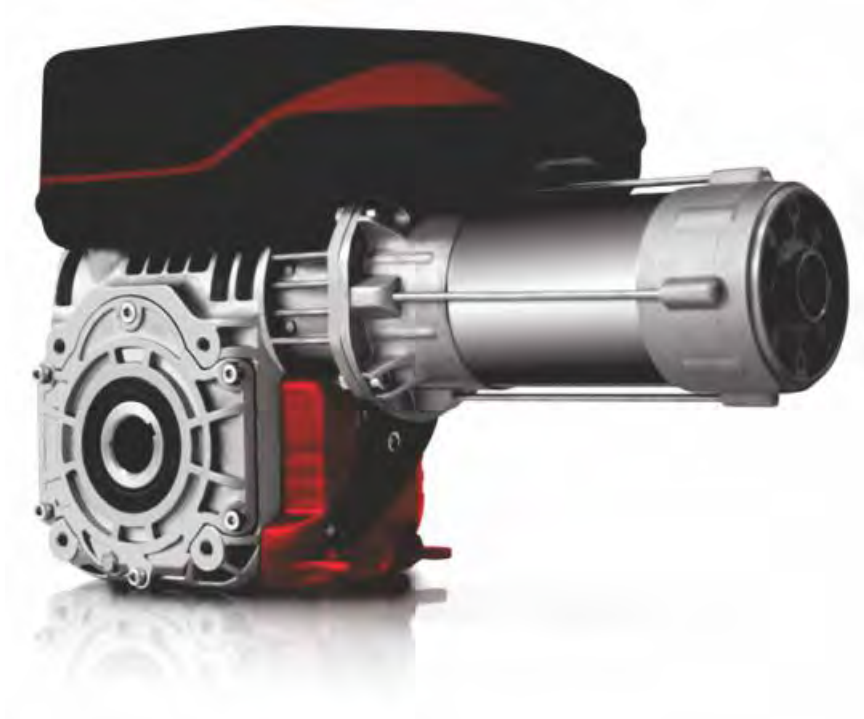

Override options

Emergency manual operation types

Hand Chain Override Standard
Hand Crank Optional

Limit switch options

Limit switch types

Mechanical Limits
Mechanical Limits (2 cams)

Technical details

DESCRIPTION	GAPL70MCH	GAPL100TCM
Torque (Nm)	70	100
Output Speed (Min ⁻¹)	21	21
Hollow Shaft (mm)	25.4	25.4
Holding Torque (Nm)	450	450
Power (kW)	0.50	0.80
Power Supply (V~)	230	415
Frequency (Hz)	50	50
Amperage (A)	2.20	2.20
Max Cycles Per Hour	12	20
Limit Switch Range	18	18
Protection Rate (IP)	54	54

GAPL70MCH motor is the standard drive

Higher range available on request

Side motors with integrated safety brake for industrial and commercial Stacking Doors

Three-phase
GAPL25TC.18

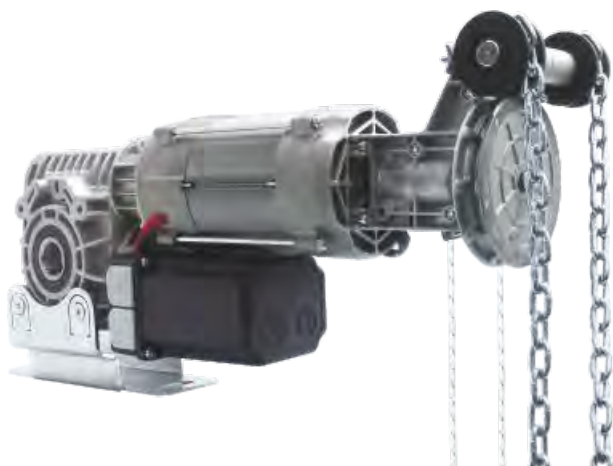

Three-phase
GAPL65TC.48



Override options

Emergency manual operation types

- Hand Chain Override Standard
- Hand Crank Optional

Limit switch options

Limit switch types

- Mechanical Limits
- Mechanical Limits (2 cams)

Technical details

DESCRIPTION	GAPL25TC.18	GAPL65TC.48
Power supply (V~)	415	415
Frequency (Hz)	50	50
Torque (Nm)	250	650
Output speed (min ⁻¹)	12	11
Power (kW)	1.1	1.5
Absorption (A)	3.0	4.5
Max cycles per hour	20	-
Duty rating (ED)	-	S3-50%
Limit switch max turns	18	10
Temperature	-5°C/40°C	-5°C/40°C
Noise (dB)	<70	<70
Protection rate (IP)	54	54
Weight (kg)	18	32

CB300 control unit as standard

Control Units

CB101

Multifunction control unit with radio receiver



CB101 is a multifunction control unit suitable for the manual or remote operation of single-phase motors up to 800 W.

Protected by an IP54 ABS box, it can control both safetybeams or safety edges (optoelectronic or traditional), with or without an autotest procedure through a simple initial selection.

Features

- Operating logic :
Semiautomatic, automatic, dead-man (only for closing)
- Manual control
 - With an additional push button to be connected with the related
 - Low-voltage plug
- Remote control
- Flashing light/courtesy light
- Safety devices :
 - Safety beams (active also for opening)
 - Safety edge
 - Optoelectronic safety edge
- Pause timer and automatic closing
- Adjustable working time, from 5 seconds to 4 minutes

Technical Specifications

DESCRIPTION	CB101		
Power supply (V~)	230Vac \pm 10% - 50Hz (single phase) / 800 W		
Exit 24V~	terminals 11 - 12, MIN 20 Vac, MAX 26.5 V~		
Exit 12Vcc	terminals 9 (+) - 3 (GND), MIN 9.5V, MAX 12.5 V		
AUX exit	terminals 13 - 14, 250V - 2A, resistive load - potential-free contact NO		
Protection fuse	4A (delayed)		
Protection rate	IP54		
Working temperature	-10°C /+60°C		
Dimensions	133 x 208 x 80 mm		
Maximum current (12V \equiv / 24V~)	Loading condition	24V~	12Vcc
	Case 1	0mA	50mA
	Case 2	70mA	40mA
	Case 3	140mA	10mA

CB300

Control unit for three-phase motors



Features

- 3phase control unit
- More room while wiring
- Quick connections for power and limits cable
- Integrated buttons in the front cover for UP, STOP and DOWN control
- Inter-locked contactors for the best reliability
- Selectable safety input = optoelectric safety edge /nc contacts for safety beams
- Auto-check
- Selectable DOWN operating mode= dead man / momentary
- Automatic closing (selectable timing)
- Colors/sequences of led for visual display of the main functions/troubleshooting
- Parallel connection facility for grouping more CB300 in one push button
- IP rating: 54

Technical Specifications

DESCRIPTION	CB300
Power supply (V~)	415V~ (3Ph) - 50/60 Hz
Power supply External accessories	24V~ / max 70mA
Motor power	max 2000 W
Protection rate	IP54
Working temperature	-10°C /+60°C
Dimensions (mm)	133 x 208 x 80

Control Units

CB500

Digital control unit for three-phase motors



Features

- 3phase digital control unit for the control of motors with digital or mechanical limit switches
- Integrated buttons in the front cover for UP, STOP and DOWN control
- Display and keyboard for the programming of limit switches and managing of the functions
- Different operating mode
- 3 entries for anti - crushing safety devices:
 - optoelectronic safety edge
 - photocells
 - safety edge
- Prepared for the addition of a radio receiver
- Prepared for the addition of a module for the management of a traffic light / courtesy lights
- Input for an external control panel
- More room while wiring

Technical Specifications

DESCRIPTION	CB500
Power supply (V~)	415V~ (3Ph) - 50/60 Hz
Power supply External accessories	24V~ / max 70mA
Motor power	max 4 kW
Protection rate	IP54
Working temperature	-10°C / +60°C
Dimensions (mm)	210 x 305 x 120

Optional Accessories

All Sectional Doors are equipped with a set of accessories that provide them with all necessary safety, aesthetic elements and robustness for perfect operation. There are, however, a series of optional accessories that may be added to a final product according to the wishes of the customers. Each accessory is subjected to rigorous tests before being selected and included in the production process, to ensure the highest quality of the product that will fulfil our customer needs.



Portholes

Rectangular window in acrylic material in black profile,
Dimension :
636 mm (w) x 333 mm (h)



Ventilation Grill

These avoid condensation and vent fumes to the outside. Available in white or black plastic, ABS material.
Dimension width x height :
344 mm x 138 mm



Flashing Light

Visually signifies door operation. Flashing light serves safety requirements. They give visual signals for opening and closing impulse.
Plastic housing IP 65

Interlocking System - Dock Leveler & Sectional Door

This prevents operation of Dock Leveler when the Sectional Door is closed or only partially open and also prevents door from closing while the Dock Leveler is still in a working position.

Interlocking System Between Two Doors

Developed for climate control or safety, paired doors interlock with control transfer function. If door A is open, door B cannot be opened. If door B is open, door A cannot be opened.



Photocells

The panel down movement is automatically stopped or reversed if the infrared beam is broken. Two distinguished functions of the photocells

- a) Open : The door opens when the photocell beam is interrupted.
- b) Safety : The door remains open as long as the photocell beam is interrupted.

Mounted on wall or column in the vicinity of a door.



Three Position Selector Switch

“Open/Stop/Close” Control
Plastic housing IP 65



Three Station Push Button

“Open/Emergency-Stop/Close” Control
Plastic housing IP 65



STAR EXPORT HOUSE
(Government of India Recognised)



ISO 9001 : 2015, ISO 14001 : 2015
ISO 45001 : 2018

Gandhi Automations operates a policy of continuous development and reserves the right to make technical modifications / replacements without prior notice.



Automations Pvt Ltd

India's No.1 Entrance Automation & Loading Bay Equipment Company

CORPORATE OFFICE

Chawda Commercial Centre, Link Road, Malad (W), Mumbai-400064, India

Tel : +91 22 6672 0200 / 6672 0300 (200 Lines)

Fax : +91 22 6672 0201

Email : sales@geapl.co.in

Website: www.geapl.co.in



TOLL FREE

1800 209 0200

From Anywhere in India

Ahmedabad - 93273 01555
Bengaluru - 93435 09090
Bhopal - 93292 94939
Bhubaneswar - 93385 69889
Chandigarh - 93176 41324
Chennai - 93809 31777
Coimbatore - 93452 99944
Goa - 93731 37970
Guwahati - 93248 98159

Hyderabad - 93473 75737
Indore - 93034 64410
Jaipur - 93520 41024
Jamshedpur - 93219 76556
Kochi - 93882 04774
Kolkata - 93300 60855
Lucknow - 93055 67760
Mangalore - 93797 41352
Nagpur - 93250 45410

New Delhi - 93131 99044
Patna - 93219 76557
Pune - 93245 30710
Raipur - 93524 40068
Ranchi - 93044 95570
Surat - 93270 97410
Vadodara - 93756 41357
Visakhapatnam - 93463 34102